

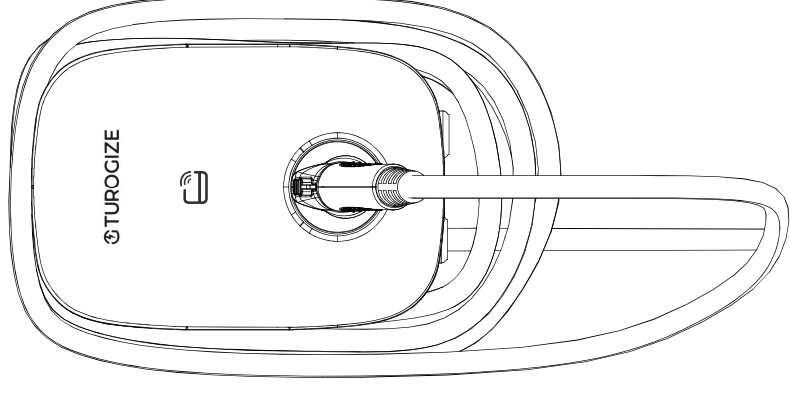

**Electric Vehicle AC Charger**  
TGA2-AC-80A/H0/J1/R/2/SL  
**User Manual**



## TABLE OF CONTENTS

## TABLE DES MATIÈRES

1. IMPORTANT SAFETY INSTRUCTIONS .....	1	1. CONSIGNES DE SÉCURITÉ IMPORTANTES .....	31
2. PRODUCT INTRODUCTIONS .....	3	2. PRÉSENTATION DU PRODUIT .....	34
3. VERIFY CONTENTS .....	5	3. VÉRIFICATION DU CONTENU .....	36
4. GATHER TOOLS .....	7	4. RASSEMBLER LES OUTILS .....	38
5. PLAN THE MOUNTING .....	8	5. PLANIFIER LE MONTAGE .....	39
6. MOUNT THE CHARGING STATION .....	10	6. MONTER LA BORNE DE RECHARGE .....	41
7. WIRE THE CIRCUIT .....	12	7. CÂBLAGE DU CIRCUIT .....	43
8. OPERATE YOUR DEVICE .....	13	8. UTILISER VOTRE APPAREIL .....	44
9. LIGHT CODES .....	17	9. CODES LUMINEUX .....	48
10. APP AND NETWORK CONFIGURATION .....	18	10. CONFIGURATION DE L'APPLICATION ET DU RÉSEAU .....	50
11. NETWORK CONFIGURATION AND YOUR EV CHARGER TO CHARPORTS APP .....	20	11. CONFIGURATION DU RÉSEAU ET JUMELAGE DE VOTRE BORNE DE RECHARGE À L'APPLICATION CHARPORTS .....	52
12. CONTROL YOUR CHARGER THROUGH APP .....	27	12. CONTRÔLER VOTRE BORNE DE RECHARGE VIA L'APPLICATION CHHARPORTS .....	59
13. WARRANTY AND MAINTENANCE .....	30	13. GARANTIE ET ENTRETIEN .....	63

**⚠ WARNING & CAUTION**

# 1. Important Safety Instructions

## 1.1 Overall Warnings & Cautions

- ⚠ WARNING:** To avoid fire, injury or death, carefully read and follow the instructions during installation, operation and maintenance.
- **DO NOT** put fingers into the electric vehicle connector.
- **DO NOT** use this product if the flexible power cord or EV cable is frayed, insulation-broken, or any other signs of damage.
- **DO NOT** use this product if the enclosure or the EV connector is broken, cracked, open, or shows any other indication of damage.
- **DO NOT** remove cover or attempt to open the enclosure because of risk of electric shock.
- ⚠ WARNING:** This device should be supervised when used around children.
- ⚠ WARNING:** This device must be grounded.
- ⚠ WARNING:** To avoid a risk of fire or electric shock, do not use this device with an extension cord.
- ⚠ WARNING:** The suitability of the use of flexible cord in accordance with CE code, part I, rule 4-012, is to be determined by the local inspection authority.
- ⚠ WARNING:** To reduce the risk of fire, connect only to a circuit provided branch circuit over-current protection in accordance with the CSA C22.1–15 Canadian Electrical Code, Part 1 (Canada) or NOM-001-SEDE Electrical installations (utility) (Mexico) or ANSI / NFPA 70 National Electrical Code (USA).

**Circuit Breaker Options table**

Output Amperage (A)	16A	32A	40A	48A	70A	80A
Circuit Breaker Options (A)	20A	40A	50A	60A	90A	100A

**⚠ WARNING & CAUTION**

## 1.2 Installation Requirements

- ⚠ WARNING:** Disconnect electrical power prior to installing the charging station.
- ⚠ WARNING:** Be sure to preview the user manual and ensure local building and electrical codes are reviewed before installing the AC charger.
- ⚠ WARNING:** The AC charger should be installed by a qualified technician according to the user manual and local safety regulations.
- ⚠ CAUTION:** Use appropriate protection when connecting to the main power distribution cable.
- ⚠ CAUTION:** Type B, C or D breaker with the rating current for table should be installed in the upstream AC distribution box.
- ⚠ CAUTION:** The device shall be mounted at height between 2 feet and 4 feet from ground.
- ⚠ CAUTION:** Please pay attention to the climatic conditions of the beach environment, such as high temperature, high humidity and other factors that may have a negative impact on the performance of EV charger, and consider using appropriate sun protection, moisture-proof and other equipment.

## 1.3 Daily Maintenance

- ⚠ CAUTION:** Avoid moisture or water in the charger. If there is water or moisture ingress in the charger, it is necessary to immediately power off to avoid immediate danger, and notify the professionals to carry out maintenance before next use.
- ⚠ CAUTION:** Please use the charger properly. Do not hit or press hard on the enclosure. If it is damaged, please contact a professional technician.
- ⚠ CAUTION:** Avoid placing the charger near hot objects and at high temperature locations and away from dangerous substances such as flammable gases and corrosive materials.
- ⚠ CAUTION:** Do not put heavy objects on the charger to avoid danger.

## 2. Product Introductions



**CAUTION:** Avoid placing the charger near hot objects and at high temperature locations and away from dangerous substances such as flammable gases and corrosive materials.

### 2.1 Basic Interface

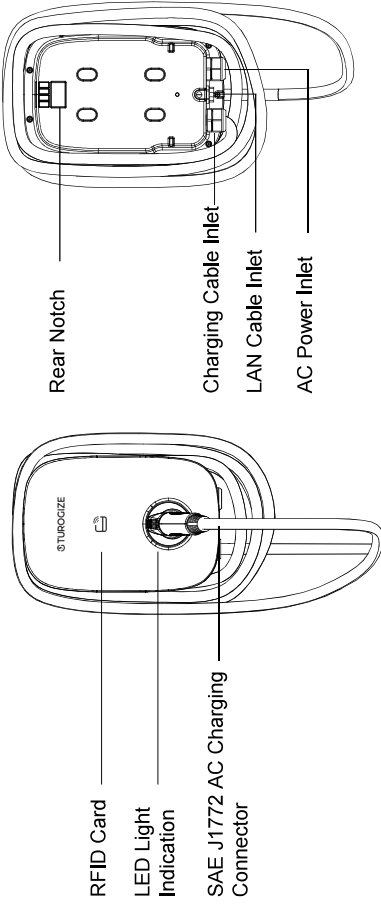

### 2.2 Basic Dimension

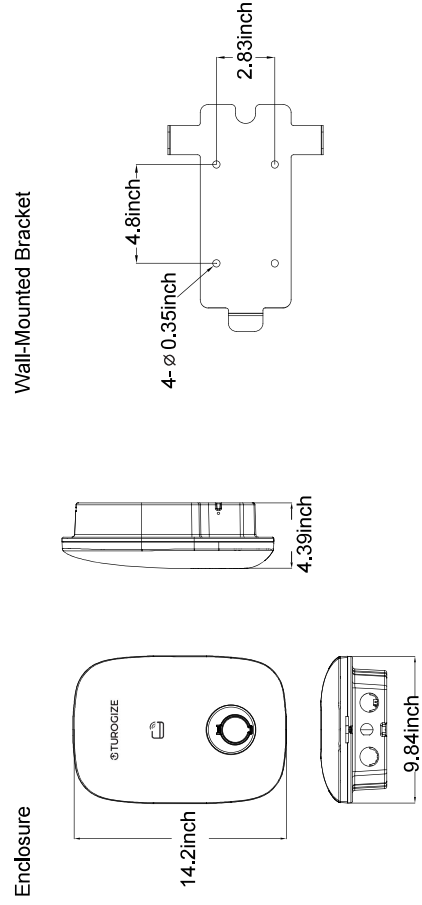

### 2.3 Specifications

Model Number	TGA2-AC-80A/H0/J1/R/2/SL
Rated Input Voltage	208 / 240VAC
Rated Output Current	80A
AC Power Frequency	50-60 Hz
Input Protection	UVP, OVP, RCD, SPD, Ground Fault Protection
Output Protection	OCP, OTP, Control Pilot Fault Protection
Output Interface	SAE J1772AC Charging Connector
Storage Temperature	-40°F to 158°F
Operation Temperature	-22°F to 122°F
Relative Operation Humidity	95% RH Maximum
Relative Storage Humidity	95% RH Maximum
Network Connection	LAN Version / Wi-Fi Version
Internet Function	10M / 100M Base-T
Wi-Fi Function	802.11 b/g/n
Cable Length	25ft
Protection Level	Type 3
Installation Type	Wall-Mounted
Altitude	≤ 6561ft
Status Indication	Red, Green, Blue LED

### 3. Verify Contents

Check the box to ensure you have this installation guide and these parts:

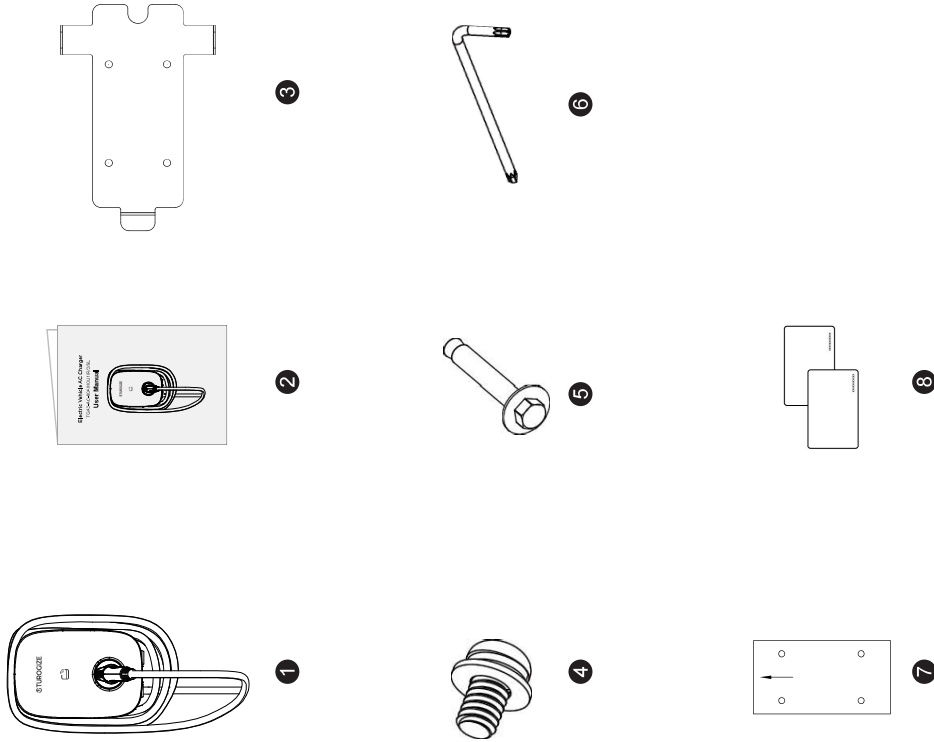

No.	Product Name	Quantity	Description
1	AC Charger	1	With attached input power cable and output charging cable
2	User Manual	1	Please read carefully before use
3	Wall-Mounted Bracket	1	For mounting the charging station to the wall / structure
4	M5 Anti-Theft Round Head Screws	2	For securing the charging station to the Mounting Bracket
5	M6 Hexagonal Expansion Screws	4	For installing the Mounting Bracket to the wall / structure
6	Allen Wrench	1	For tightening M5 Screws
7	Corrugated Mounting Template	1	For easy drilling of 4 screws holes for wall-mounted bracket
8	RFID Card (Optional)	2	Control the charger start / stop

## 4. Gather Tools

Tools required before installing the Wall-Mounted charger, gather the following tools:

1. Wire stripper
2. Adjustable Wrench
3. Voltmeter or digital multi-meter (for measuring AC voltage at the installation site)
4. Level
5. Pencil or marker
6. Drill
7. Phillips screwdriver

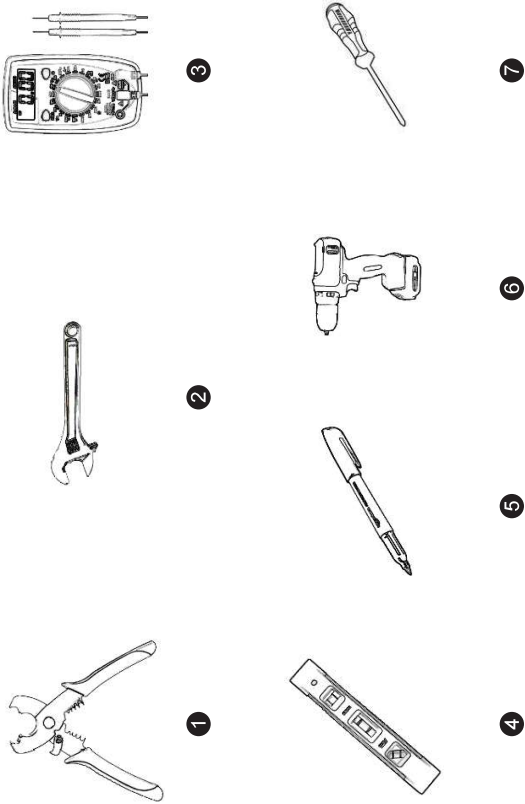

Note: The above tools are very important, please gather them all.

## 5. Plan The Mounting



**WARNING:** In areas with frequent thunderstorms, add surge protection at the service panel for all circuits. Ensure all power and ground connections, especially those at the breaker and bus bar, are clean and tight.



**CAUTION:** Please pay attention to the climatic conditions of the beach environment, such as high temperature, high humidity and other factors that may have a negative impact on the performance of EV charger, and consider using appropriate sun protection, moisture-proof and other equipment.

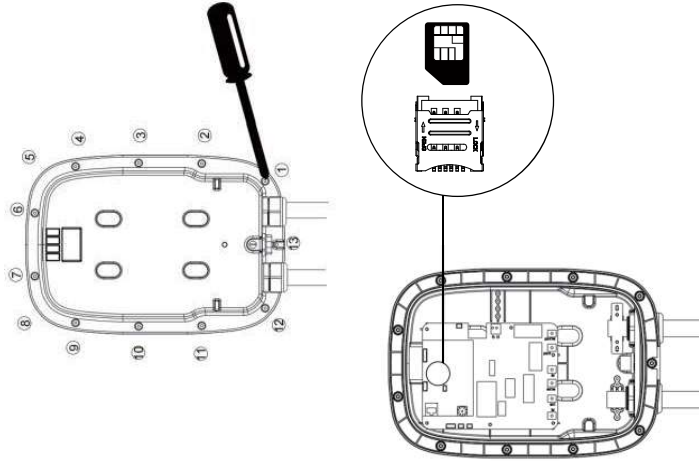

### STEP 1 (Only for 4G Version)

Use screwdriver to loosen the 13 fixed screws on the rear of charger, then remove the front cover (for 4G Version).

### STEP 2 (Only for 4G Version)

Insert the SIM card according to the picture's instruction (for 4G Version).

**STEP 3 (Only for 4G Version)**

Tighten 13 screws on the front cover after the front cover is put back, the recommended screw torque is 1.0 N.m (9.6 lbf.in) (for 4G Version). clean and tight.

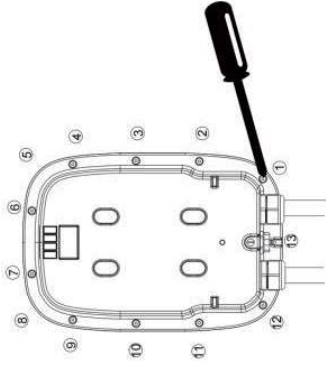

**STEP 4**

Select the appropriate mounting location with electrical capacity.

- I. Ensure the owner has chosen a mounting location that allows the charging cable to reach the car's charging port while still providing slack.
- II. The device must be anchored into mounting such as 3.14" x 5.11" stud or a solid wall.
- III. The device shall be mounted at height between 2 feet and 4 feet from ground.

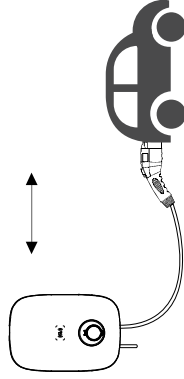

**STEP 5**

Drill 4 Screw Holes with a diameter of 0.32" and a depth of 2.04" by using our mounting template. Please drill screw holes in the direction of the template arrow.

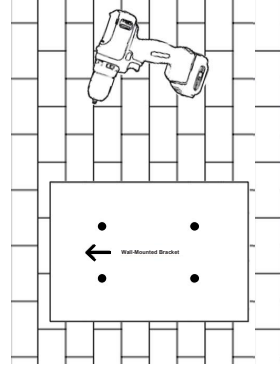

**6. Mount the Charging Station**

**STEP 1**

Use 4 sets Hexagonal Expansion Screws to secure the wall-mounted bracket on the wall. Then level the brackets.

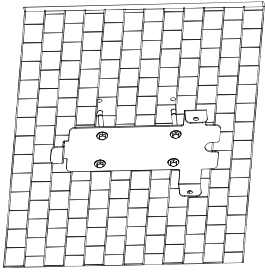

**STEP 2**

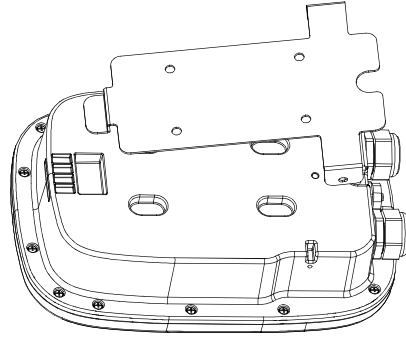

Align the rear notch of charger with the wall-mounted bracket and fit the screw holes of the right and left side.

**STEP 3**

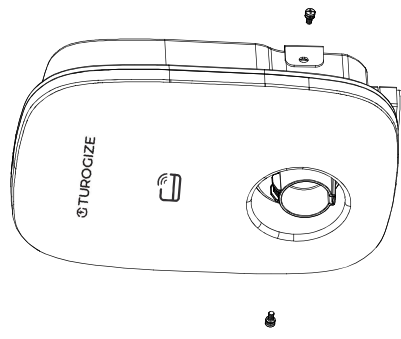

Tighten two M5 anti-theft screws to complete the installation.

STEP 4

Overall outlook picture after installation.

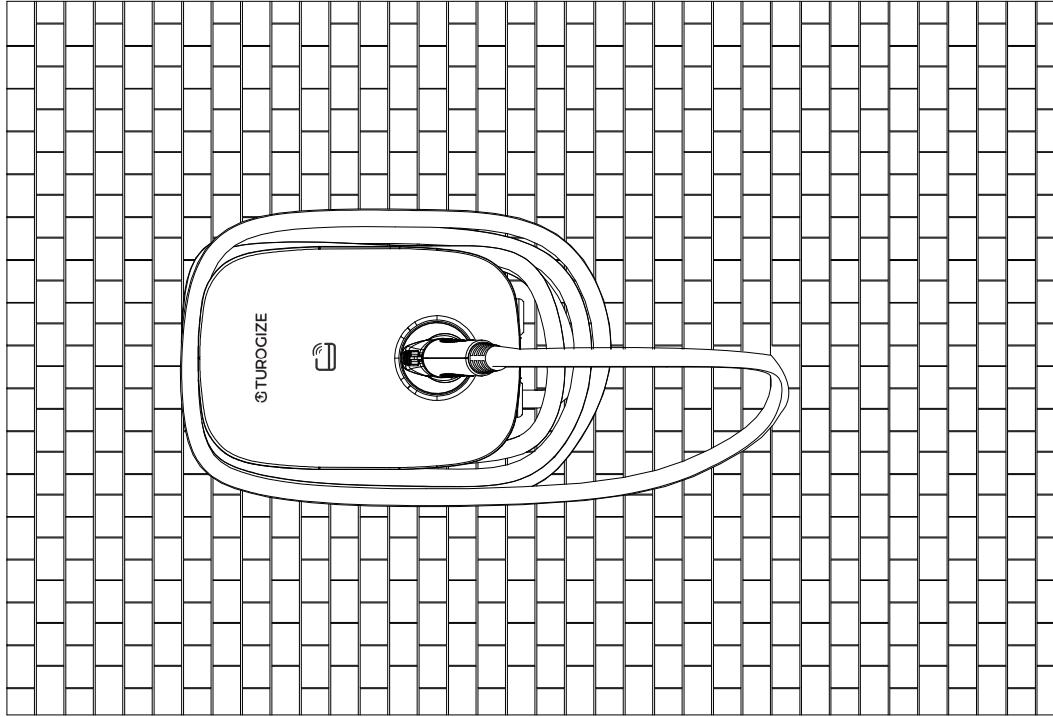

## 7. Wire The Circuit



**WARNING:** This device must be grounded. Disconnect electrical power prior to installing the charging station.



**WARNING:** Improper connection of the equipment-grounding conductor would result in a risk of electric shock. Check with a qualified electrician or serviceman if you are not sure whether the product is properly grounded. Do not modify the plug provided with the product – if it doesn't fit the outlet, have a proper outlet installed by a qualified electrician.



**CAUTION:** Use appropriate protection when connecting to the main power distribution cable.

For safe use of electricity, please set circuit breaker protection in the input part of EV Charger. The wiring is not complicated, just need to follow the instructions below:

Connect the L1 lead to the grid L1,

connect the L2 lead to the grid L2, connect the PE lead to the grid PE.

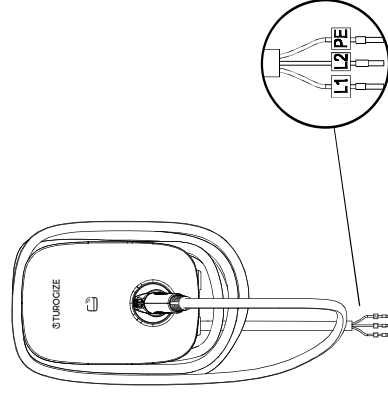

Circuit Breaker Options table

Output Amperage (A)	16A	32A	40A	48A	70A	80A
Circuit Breaker Options (A)	20A	40A	50A	60A	90A	100A

## 8. Operate Your Device



**WARNING:** This device should be supervised when used around children.



**CAUTION:** Please use the charger properly. Do not hit or press hard on the enclosure. If the case is damaged, please contact a professional technician.



**CAUTION:** Do not put heavy objects on the charger to avoid danger.

### 8.1 Operating Steps with Plug and Charge

#### STEP 1

##### Standby Mode:

After being powered on, the lights will be all on, blue light (READY), green light (CHARGE) and red light (FAULT). Then the blue light (READY) is constantly on in standby mode.

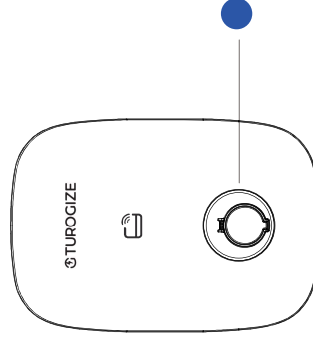

#### STEP 2

##### Plug the Charging Connector:

Please plug the charging connector into the vehicle charging inlet.



#### STEP 3

##### Charging:

The green light (CHARGE) turns to flash automatically, charging is in process.

- If the red light (FAULT) is on, plug the vehicle connector again.
- If red light is still on, please refer to "Error and Warning Messages".

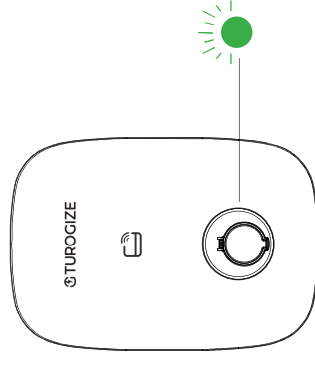

#### STEP 4

##### Charging finished:

When the charging is finished, the green light (CHARGE) is constantly on, pull out the charging connector.

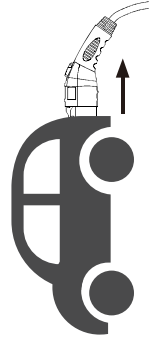

## 8.2 Operating Steps with RFID (Optional)



**CAUTION:** Please keep your RFID card properly to avoid unnecessary loss.

### STEP 1

#### Standby Mode:

After power-on, blue light (READY), green light (CHARGE) and red light (FAULT) all on. The blue light (READY) is constantly on when in standby mode.

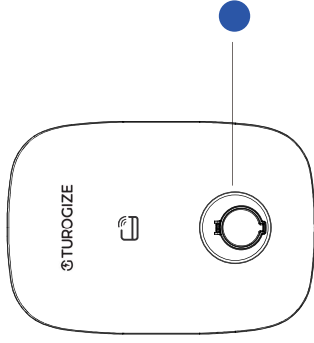

### STEP 2

#### Ready to charge:

Please plug the charging connector into the vehicle charging inlet. When the green light (CHARGE) is constantly on, the user can swipe the RFID Card.

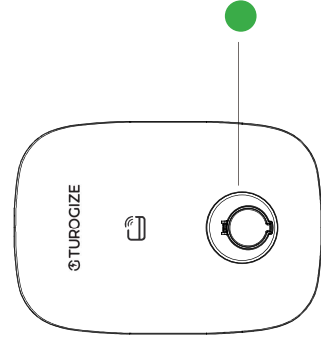
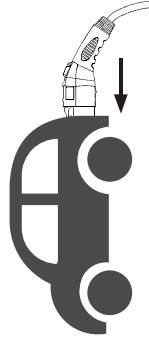

### STEP 3

#### Swipe the RFID Card:

Swipe the RFID card first and plug in the charging connector within 120 seconds, otherwise you need to swipe the RFID card again.

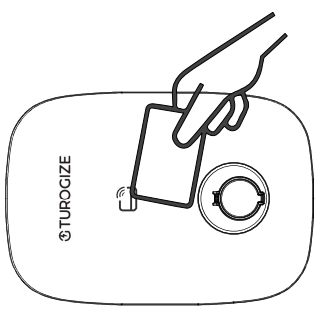

### STEP 4

#### Charging:

The green light (CHARGE) turns to flash automatically, charging is in process.

- If the red light (FAULT) is on, plug in the charging connector again.
- If red light is still on, please refer to "Error and Warning Messages".

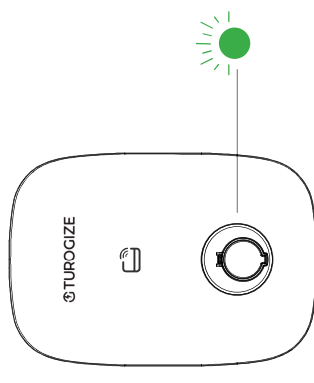

### STEP 5

#### Charging finished:

When the charging is finished or swipe your RFID card, the green light (CHARGE) is constantly on. Please press the button on connector and pull out the charging connector.

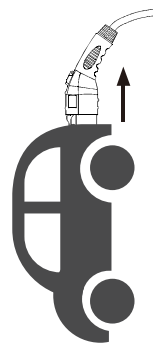
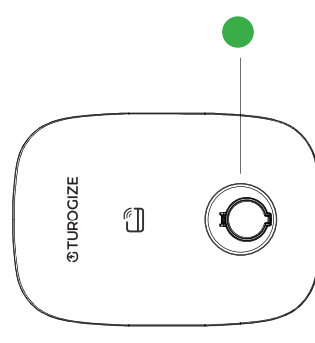

## 9. Light Codes

### 9.1 After Start UP

Standby, waiting to plug in	Waiting to charge, communicating with vehicle	Charging in progress	Finished charging	Fault
Solid Blue	Solid Green	Green Blinking	Solid Green	Solid Red

### 9.2 Error and Warning Messages

Status	Red	Remark
Emergency Fault	Constantly Bright	Rotate to Reset Emergency Button
Input OVP	1 flash followed by 3 sec pause	Auto Recover
Input UVP	2 flashes followed by 3 sec pause	Auto Recover
Output OCP	3 flashes followed by 3 sec pause	Unplug the Connector to Recover
OTP	4 flashes followed by 3 sec pause	Auto Recover
RCD Abnormal	5 flashes followed by 3 sec pause	Unplug the Connector to Recover
Ground Fault	6 flashes followed by 3 sec pause	Auto Recover
Control Pilot Fault	7 flashes followed by 3 sec pause	Unplug the Connector to Recover
Relay Fault	8 flashes followed by 3 sec pause	Contact Customer Service
RCD Self-Test Fail	9 flashes followed by 3 sec pause	Contact Customer Service
Relay Self-Test Fail	10 flashes followed by 3 sec pause	Contact Customer Service
Meter Fault	Slow blinking	Contact Customer Service

Note: If the problem occurs, please contact customer service: support@turogize.com

## 10. APP and Network configuration

### 10.1 Download and Register Charports APP

1) Scan QR code to download APP from IOS or Google APP store.



IOS



Google

2) Tap "Private" on the top of the page

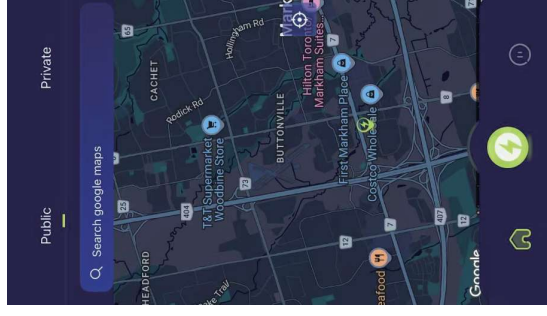

3) Tap "Register An Account" to create an account.

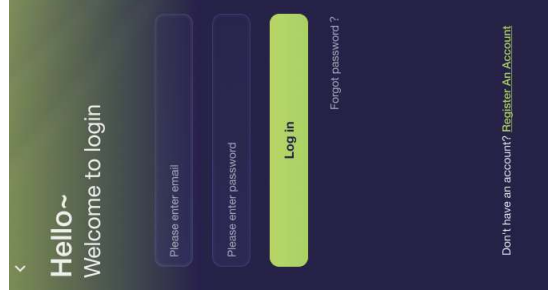

- Enter a valid email address and create a secure password.
- A verification email will be sent to your inbox.
- Input the verification code into the APP.

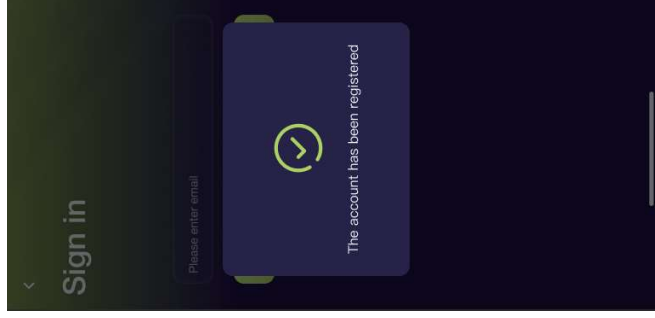

- If the email address is already associated with an account, you will be prompted to log in directly.
- Reset your password:
  - If you forget your password, tap "Forgot Password" on the login screen.
  - Enter your registered email address. A verification code will be sent to your inbox. Input the verification code into the APP and follow the on-screen instructions to set a new password.

## 11. Network Configuration and Connect to Charports APP

Before using your EV charger for the first time, complete the following three-step setup process through Bluetooth. Once finished, you will have full access to all charger controls through the Device Details screen.

### STEP 1

#### Device Pairing

Ensure the charger is powered on. In Charports APP, navigate to the "Private" tab and tap "Add Charging Point." Select your charger model, then follow the on-screen prompts to prepare for network pairing — this includes turning on the Bluetooth function of your mobile phone.

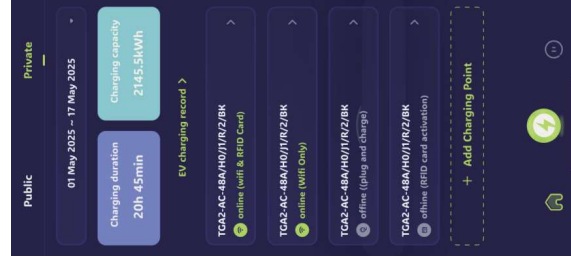

Following the prompts, tap "Done" to initiate a search for nearby Bluetooth devices. Once the search is complete, locate and select the Bluetooth name corresponding to your charging station (as specified in the manual) and tap "Connect." Upon a successful connection, you will be prompted to select the station's access mode.

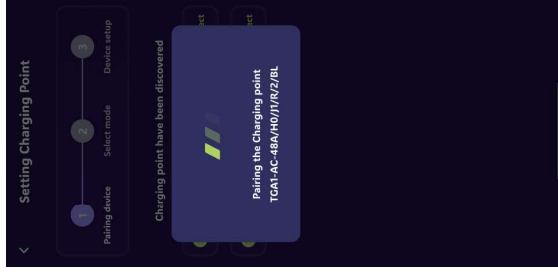
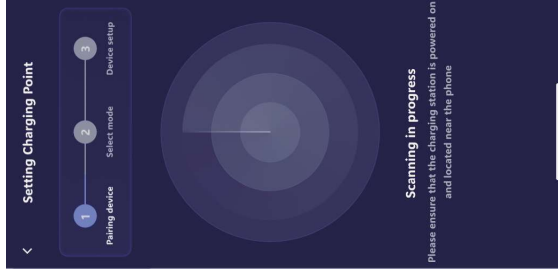

**STEP 2**

**Select Connection Mode**

Based on the available network at the installation site, select either "Online" or "Offline" operating mode.

**Online Mode ---**

• App + RFID Card: When connected to the internet, charging sessions can be started through the app or by tapping a paired RFID card at the charger.

• App Only: When connected to the internet, charging sessions can only be started through the app.

**Offline Mode ---**

• Plug-and-Charge: In offline mode, a charging session starts automatically when the vehicle connector is plugged in.

• RFID Card: In offline mode, a charging session is started by tapping a paired RFID card at the charger.



**STEP 3**

**Device Configuration**

Enter all required configuration parameters, including the network connection method and any RFID card pairings. Review your settings and tap Save to complete the initial setup.

**Online Mode ---**

- App + RFID Card: Configure the charger's network connection settings and RFID card pairings, then complete the remaining charger settings.

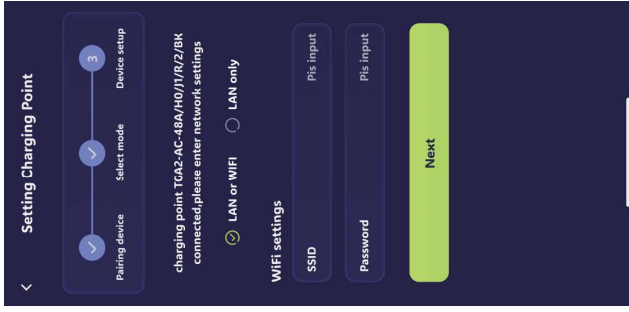

- App Only: Configure the charger's network connection settings, then complete the remaining charger settings.

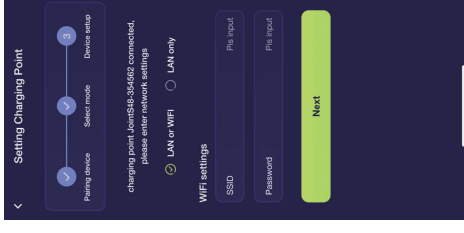

**Offline Mode ---**

- Plug-and-Charge: No network configuration is required. Proceed directly to the charger settings.
- RFID Card: Configure the RFID card pairing, then complete the remaining charger settings.



After all settings have been entered and saved, Charports APP will transmit the configuration data to the charger. The charger will restart automatically to apply the new settings. At this point, you may disable Airplane Mode on your phone and reconnect to your regular internet connection.

After entering the required information for the selected mode, the App will transmit the settings to the charging station. The station will then reboot to apply the new configuration.

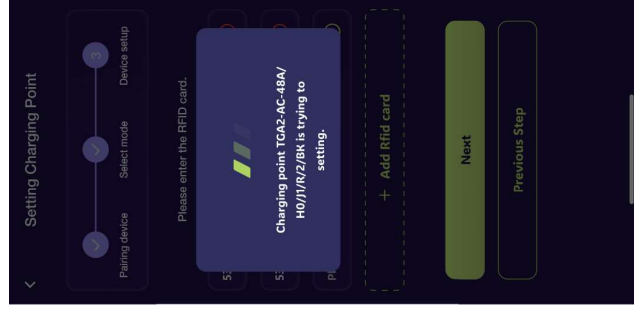

Once your phone reconnects to the internet, the newly added charger will appear in your Home Charger list.

If you need to change the connection mode at any time, tap "..." on the Charger Details screen and select "Switch Connection Method" to restart the setup process.

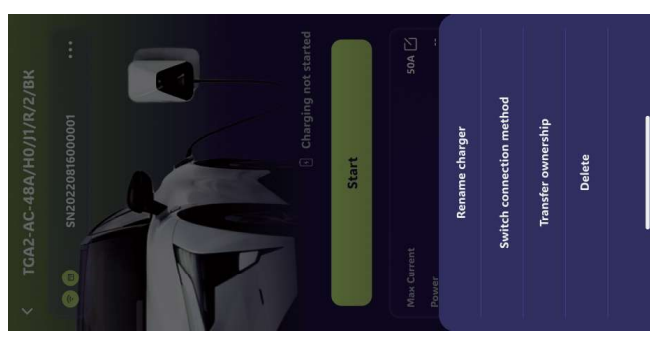

## 12. Control Your Charger Through APP

Once your charger has been successfully added, tap on it to open the Device Details screen, where you can access the following controls:

### 1) Charge Session Control

In Online mode, you can start and stop charging sessions directly from APP.

- Start Charging: Tap “Start” to begin a charging session.
- Stop Charging: Tap “Stop” at any time to end the charging session immediately.

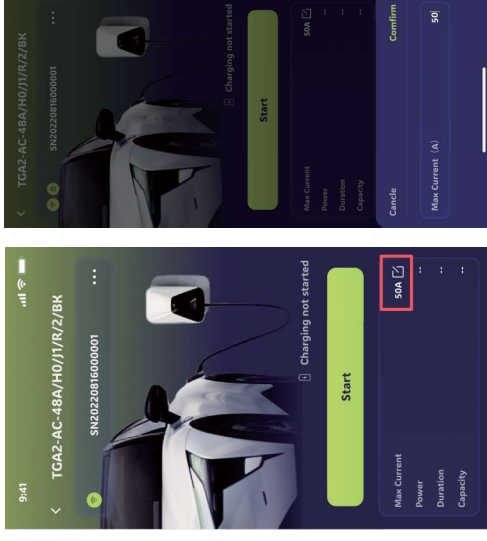
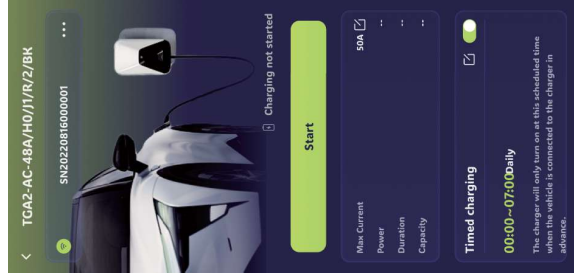

### 3) Scheduled Charging

Time Window Setting: Set a specific start and end time for automatic charging.

For example, you can schedule sessions during off-peak hours — such as overnight — to take advantage of lower electricity rates available under time-of-use (TOU) programs offered by many Canadian utilities.

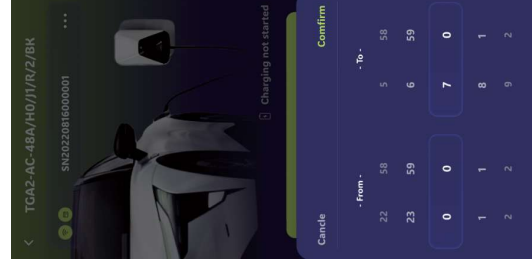
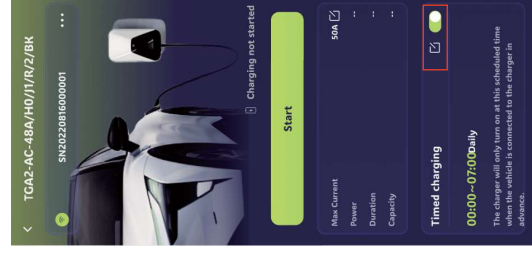

### 2) Current Limit Adjustment

Maximum Current Setting: In Online mode, tap the current settings option and enter a value to cap the maximum output current. This helps protect your home's electrical panel and manage load on your electrical service.

4) Authorized User Management

Add / View Users: Manage the list of accounts that have permission to control this charger. Authorized users can view this charger in their Home Charger list and start or stop charging sessions through the APP.

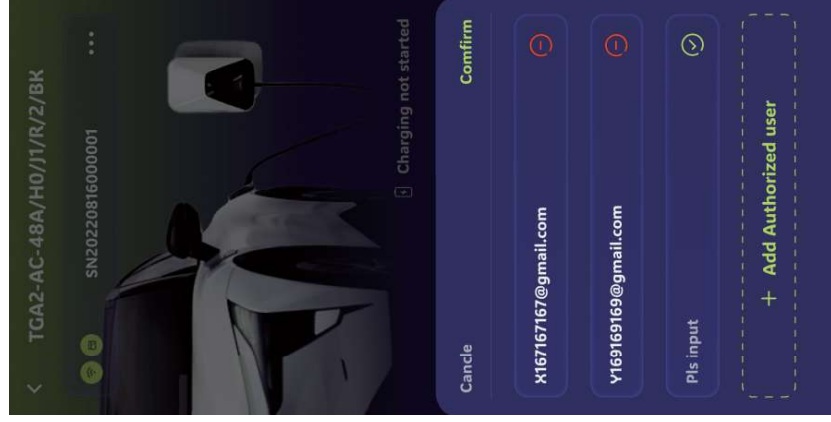
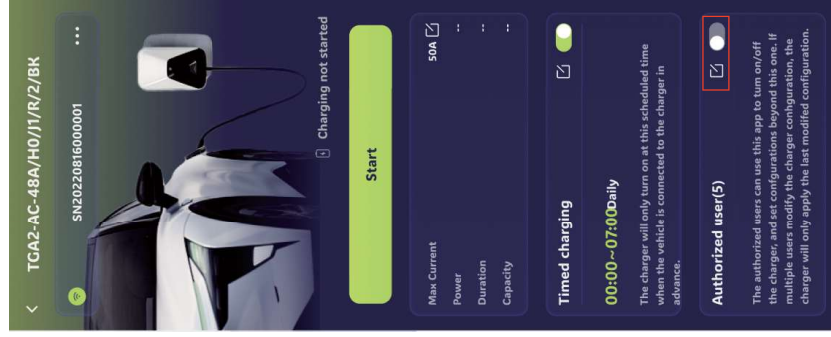

13. Warranty and Maintenance

- The warranty period for this charger is two years.
- During the warranty period for any malfunction under normal use according to the User Manual (to be determined by certified maintenance technicians of sellers), the product shall be repaired free of charge. Except for the following situations, the charger shall be subject to the above warranty terms:

1. The warranty certificate cannot be provided or the contents of the warranty certificate are modified or inconsistent with the label indication of the repaired product.
  2. Those who are unable to provide valid proof of purchase.
  3. Those who exceed the manufacturer's specified warranty period.
  4. Those who damage the product due to not following the product service instruction for use, maintenance and storage.
  5. Damage or malfunction caused by external object entering.
  6. Unauthorized repair, disassembly or modification.
  7. Damage caused by force majeure (such as lightning, excessive voltage, earthquake, fire, flood, etc.).
  8. Malfunction and damage caused by other unavoidable external factors. Malfunction and damage caused by improper use of equipment, such as water or other solutions entering into the equipment.
  9. Malfunction and damage caused by the grid power supply and voltage which is not specified for use with the charger equipment.
- The above guarantees shall be made solely, and no other express or implied warranties shall be made (including the implied warranties of merchant ability, particular and applicable reason-ableness and adaptability, etc.) whether in the contract, civil negligence, or other aspects, the Company shall not be responsible for any special, incidental or consequential damages.